

# General Purpose Transistors

## NPN Silicon

### 2N3903, 2N3904

#### Features

- Pb-Free Packages are Available\*

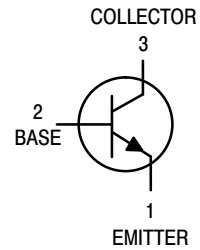

#### MAXIMUM RATINGS

Rating	Symbol	Value	Unit
Collector - Emitter Voltage	$V_{CEO}$	40	Vdc
Collector - Base Voltage	$V_{CBO}$	60	Vdc
Emitter - Base Voltage	$V_{EBO}$	6.0	Vdc
Collector Current - Continuous	$I_C$	200	mAdc
Total Device Dissipation @ $T_A = 25^\circ\text{C}$ Derate above $25^\circ\text{C}$	$P_D$	625 5.0	mW mW/ $^\circ\text{C}$
Total Device Dissipation @ $T_C = 25^\circ\text{C}$ Derate above $25^\circ\text{C}$	$P_D$	1.5 12	W mW/ $^\circ\text{C}$
Operating and Storage Junction Temperature Range	$T_J, T_{stg}$	-55 to +150	$^\circ\text{C}$

#### THERMAL CHARACTERISTICS (Note 1)

Characteristic	Symbol	Max	Unit
Thermal Resistance, Junction-to-Ambient	$R_{\theta JA}$	200	$^\circ\text{C}/\text{W}$
Thermal Resistance, Junction-to-Case	$R_{\theta JC}$	83.3	$^\circ\text{C}/\text{W}$

Stresses exceeding those listed in the Maximum Ratings table may damage the device. If any of these limits are exceeded, device functionality should not be assumed, damage may occur and reliability may be affected.

1. Indicates Data in addition to JEDEC Requirements.

TO-92  
CASE 29  
STYLE 1

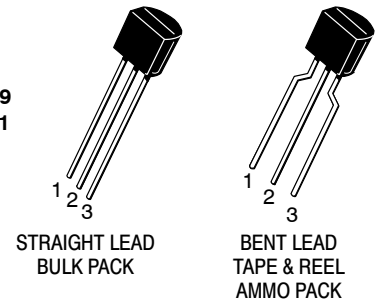

#### MARKING DIAGRAMS

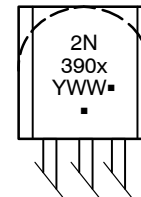

- x = 3 or 4
- Y = Year
- WW = Work Week
- = Pb-Free Package

(Note: Microdot may be in either location)

#### ORDERING INFORMATION

See detailed ordering and shipping information in the package dimensions section on page 3 of this data sheet.

\*For additional information on our Pb-Free strategy and soldering details, please download the onsemi Soldering and Mounting Techniques Reference Manual, SOLDERRM/D.

## 2N3903, 2N3904

### ELECTRICAL CHARACTERISTICS ( $T_A = 25^\circ\text{C}$ unless otherwise noted)

Characteristic	Symbol	Min	Max	Unit
<b>OFF CHARACTERISTICS</b>				
Collector – Emitter Breakdown Voltage (Note 2) ( $I_C = 1.0 \text{ mAdc}$ , $I_B = 0$ )	$V_{(BR)CEO}$	40	–	Vdc
Collector – Base Breakdown Voltage ( $I_C = 10 \mu\text{Adc}$ , $I_E = 0$ )	$V_{(BR)CBO}$	60	–	Vdc
Emitter – Base Breakdown Voltage ( $I_E = 10 \mu\text{Adc}$ , $I_C = 0$ )	$V_{(BR)EBO}$	6.0	–	Vdc
Base Cutoff Current ( $V_{CE} = 30 \text{ Vdc}$ , $V_{EB} = 3.0 \text{ Vdc}$ )	$I_{BL}$	–	50	nAdc
Collector Cutoff Current ( $V_{CE} = 30 \text{ Vdc}$ , $V_{EB} = 3.0 \text{ Vdc}$ )	$I_{CEX}$	–	50	nAdc

### ON CHARACTERISTICS

DC Current Gain (Note 2) ( $I_C = 0.1 \text{ mAdc}$ , $V_{CE} = 1.0 \text{ Vdc}$ )  ( $I_C = 1.0 \text{ mAdc}$ , $V_{CE} = 1.0 \text{ Vdc}$ )  ( $I_C = 10 \text{ mAdc}$ , $V_{CE} = 1.0 \text{ Vdc}$ )  ( $I_C = 50 \text{ mAdc}$ , $V_{CE} = 1.0 \text{ Vdc}$ )  ( $I_C = 100 \text{ mAdc}$ , $V_{CE} = 1.0 \text{ Vdc}$ )	2N3903	$h_{FE}$	20	–	–
	2N3904		40	–	–
	2N3903		35	–	–
	2N3904		70	–	–
	2N3903		50	150	–
	2N3904		100	300	–
	2N3903		30	–	–
	2N3904		60	–	–
Collector – Emitter Saturation Voltage (Note 2) ( $I_C = 10 \text{ mAdc}$ , $I_B = 1.0 \text{ mAdc}$ ) ( $I_C = 50 \text{ mAdc}$ , $I_B = 5.0 \text{ mAdc}$ )		$V_{CE(sat)}$	–	0.2	Vdc
			–	0.3	
Base – Emitter Saturation Voltage (Note 2) ( $I_C = 10 \text{ mAdc}$ , $I_B = 1.0 \text{ mAdc}$ ) ( $I_C = 50 \text{ mAdc}$ , $I_B = 5.0 \text{ mAdc}$ )		$V_{BE(sat)}$	0.65	0.85	Vdc
			–	0.95	

### SMALL-SIGNAL CHARACTERISTICS

Current – Gain – Bandwidth Product ( $I_C = 10 \text{ mAdc}$ , $V_{CE} = 20 \text{ Vdc}$ , $f = 100 \text{ MHz}$ )	2N3903 2N3904	$f_T$	250 300	– –	MHz
Output Capacitance ( $V_{CB} = 5.0 \text{ Vdc}$ , $I_E = 0$ , $f = 1.0 \text{ MHz}$ )		$C_{obo}$	–	4.0	pF
Input Capacitance ( $V_{EB} = 0.5 \text{ Vdc}$ , $I_C = 0$ , $f = 1.0 \text{ MHz}$ )		$C_{ibo}$	–	8.0	pF
Input Impedance ( $I_C = 1.0 \text{ mAdc}$ , $V_{CE} = 10 \text{ Vdc}$ , $f = 1.0 \text{ kHz}$ )	2N3903 2N3904	$h_{ie}$	1.0 1.0	8.0 10	k $\Omega$
Voltage Feedback Ratio ( $I_C = 1.0 \text{ mAdc}$ , $V_{CE} = 10 \text{ Vdc}$ , $f = 1.0 \text{ kHz}$ )	2N3903 2N3904	$h_{re}$	0.1 0.5	5.0 8.0	$\times 10^{-4}$
Small-Signal Current Gain ( $I_C = 1.0 \text{ mAdc}$ , $V_{CE} = 10 \text{ Vdc}$ , $f = 1.0 \text{ kHz}$ )	2N3903 2N3904	$h_{fe}$	50 100	200 400	–
Output Admittance ( $I_C = 1.0 \text{ mAdc}$ , $V_{CE} = 10 \text{ Vdc}$ , $f = 1.0 \text{ kHz}$ )		$h_{oe}$	1.0	40	$\mu\text{mhos}$
Noise Figure ( $I_C = 100 \mu\text{Adc}$ , $V_{CE} = 5.0 \text{ Vdc}$ , $R_S = 1.0 \text{ k}\Omega$ , $f = 1.0 \text{ kHz}$ )	2N3903 2N3904	NF	– –	6.0 5.0	dB

### SWITCHING CHARACTERISTICS

Delay Time	$(V_{CC} = 3.0 \text{ Vdc}$ , $V_{BE} = 0.5 \text{ Vdc}$ , $I_C = 10 \text{ mAdc}$ , $I_{B1} = 1.0 \text{ mAdc}$ )		$t_d$	–	35	ns
Rise Time			$t_r$	–	35	ns
Storage Time	$(V_{CC} = 3.0 \text{ Vdc}$ , $I_C = 10 \text{ mAdc}$ , $I_{B1} = I_{B2} = 1.0 \text{ mAdc}$ )	2N3903 2N3904	$t_s$	–	175 200	ns
Fall Time			$t_f$	–	50	ns

2. Pulse Test: Pulse Width  $\leq 300 \mu\text{s}$ ; Duty Cycle  $\leq 2\%$ .

## 2N3903, 2N3904

### ORDERING INFORMATION

Device	Package	Shipping†
2N3903RLRM	TO-92	2000 / Ammo Pack
2N3904	TO-92	5000 Units / Bulk
2N3904G	TO-92 (Pb-Free)	5000 Units / Bulk
2N3904RLRA	TO-92	2000 / Tape & Reel
2N3904RLRAG	TO-92 (Pb-Free)	2000 / Tape & Reel
2N3904RLRM	TO-92	2000 / Ammo Pack
2N3904RLRMG	TO-92 (Pb-Free)	2000 / Ammo Pack
2N3904RLRP	TO-92	2000 / Ammo Pack
2N3904RLRPG	TO-92 (Pb-Free)	2000 / Ammo Pack
2N3904RL1G	TO-92 (Pb-Free)	2000 / Tape & Reel
2N3904ZL1	TO-92	2000 / Ammo Pack
2N3904ZL1G	TO-92 (Pb-Free)	2000 / Ammo Pack

†For information on tape and reel specifications, including part orientation and tape sizes, please refer to our Tape and Reel Packaging Specifications Brochure, BRD8011/D.

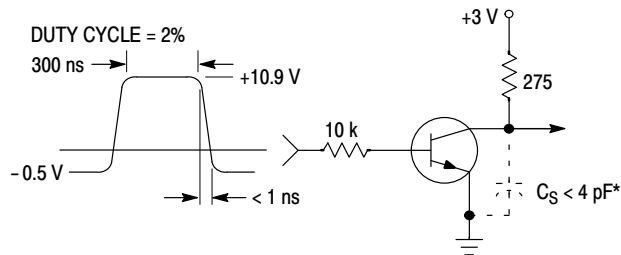

\* Total shunt capacitance of test jig and connectors

**Figure 1. Delay and Rise Time Equivalent Test Circuit**

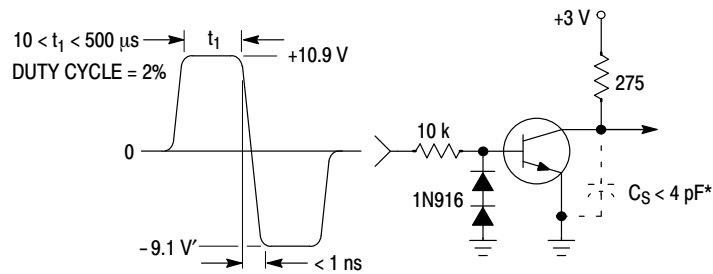

\* Total shunt capacitance of test jig and connectors

**Figure 2. Storage and Fall Time Equivalent Test Circuit**

TYPICAL TRANSIENT CHARACTERISTICS

—  $T_J = 25^\circ\text{C}$   
 - - -  $T_J = 125^\circ\text{C}$

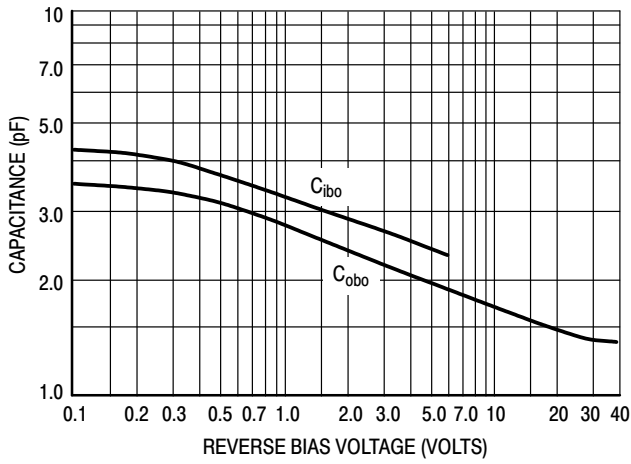

Figure 3. Capacitance

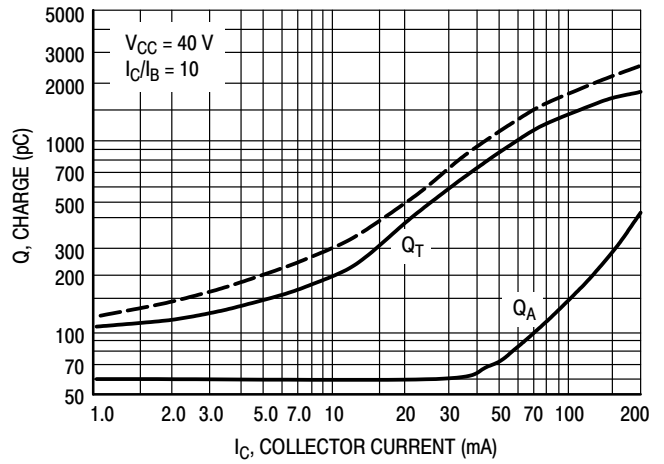

Figure 4. Charge Data

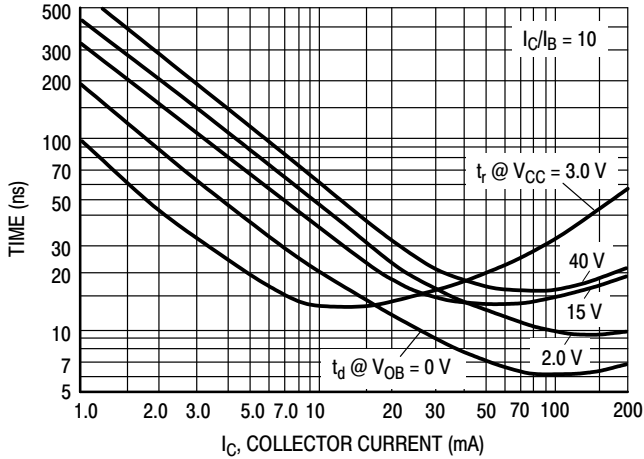

Figure 5. Turn-On Time

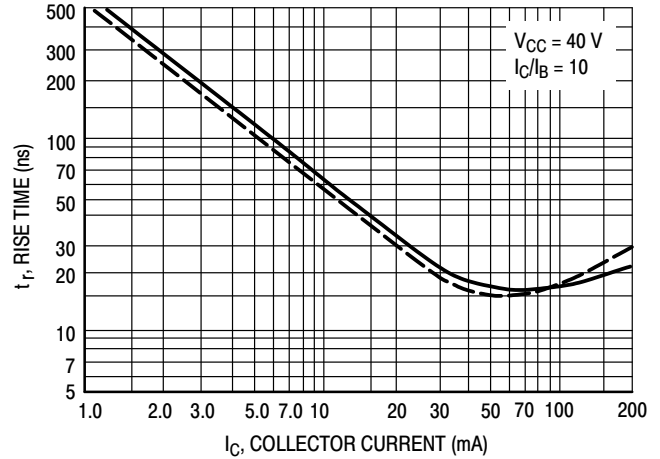

Figure 6. Rise Time

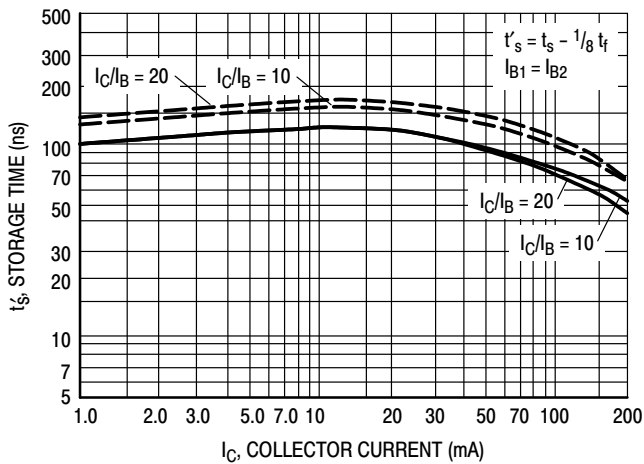

Figure 7. Storage Time

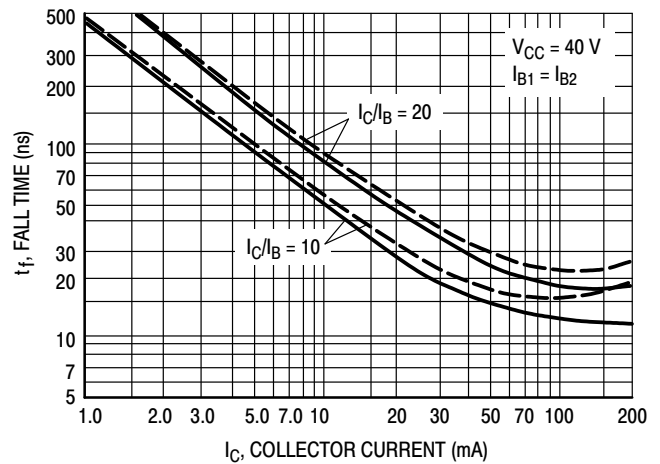

Figure 8. Fall Time

# 2N3903, 2N3904

## TYPICAL AUDIO SMALL-SIGNAL CHARACTERISTICS NOISE FIGURE VARIATIONS

( $V_{CE} = 5.0 \text{ Vdc}$ ,  $T_A = 25^\circ\text{C}$ , Bandwidth = 1.0 Hz)

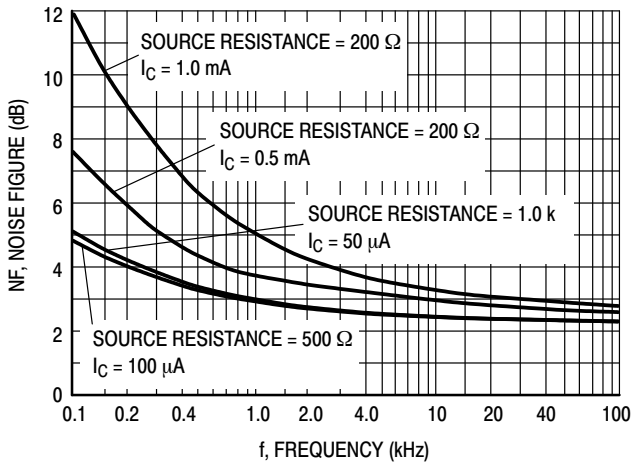

Figure 9.

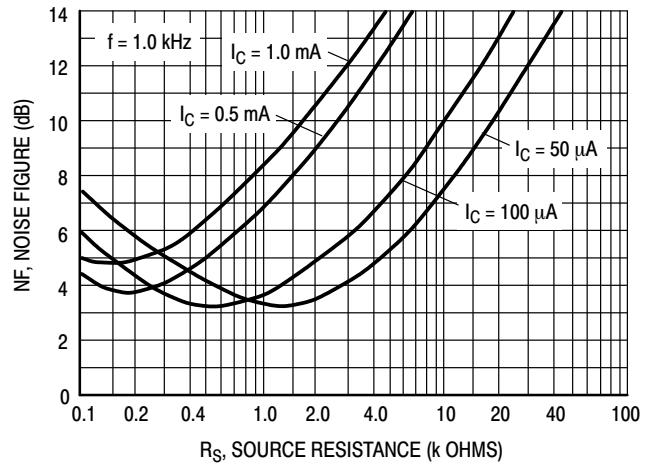

Figure 10.

## h PARAMETERS

( $V_{CE} = 10 \text{ Vdc}$ ,  $f = 1.0 \text{ kHz}$ ,  $T_A = 25^\circ\text{C}$ )

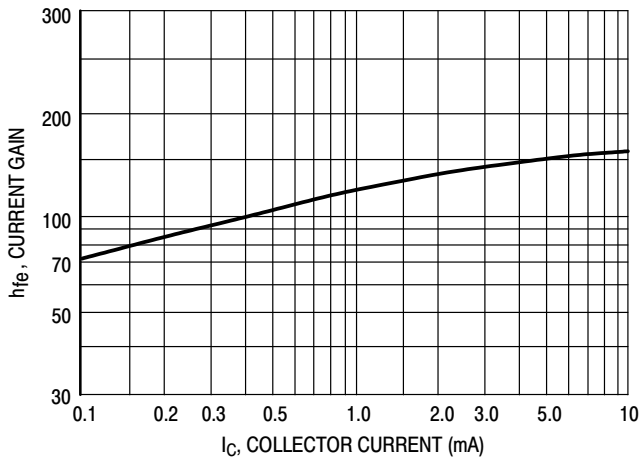

Figure 11. Current Gain

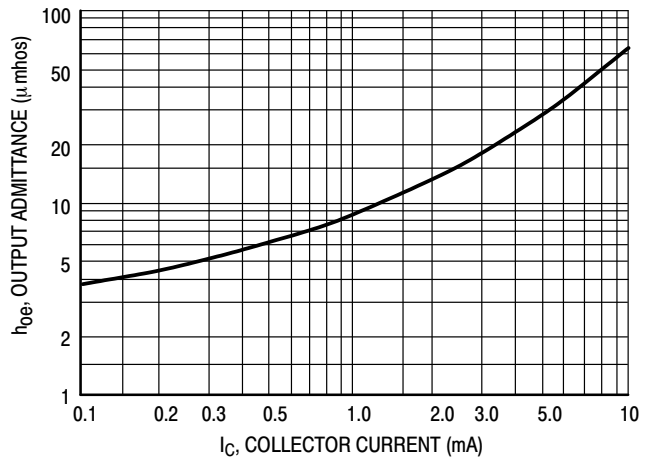

Figure 12. Output Admittance

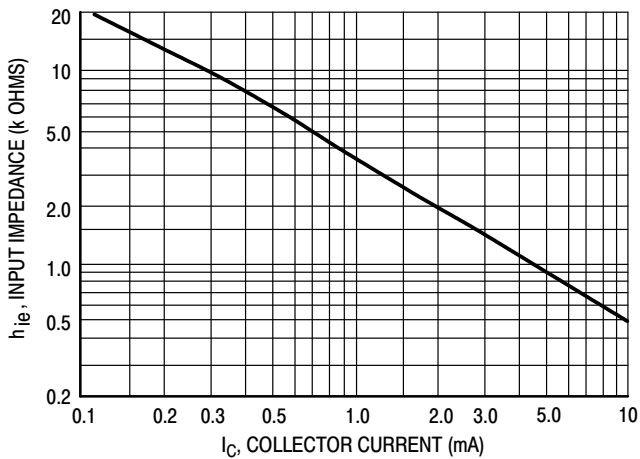

Figure 13. Input Impedance

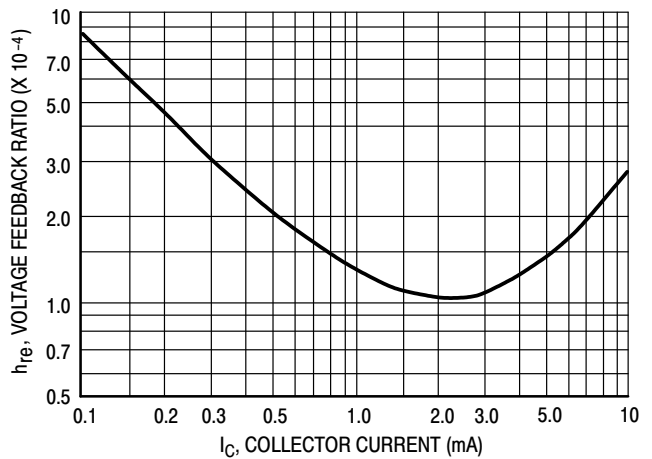

Figure 14. Voltage Feedback Ratio

TYPICAL STATIC CHARACTERISTICS

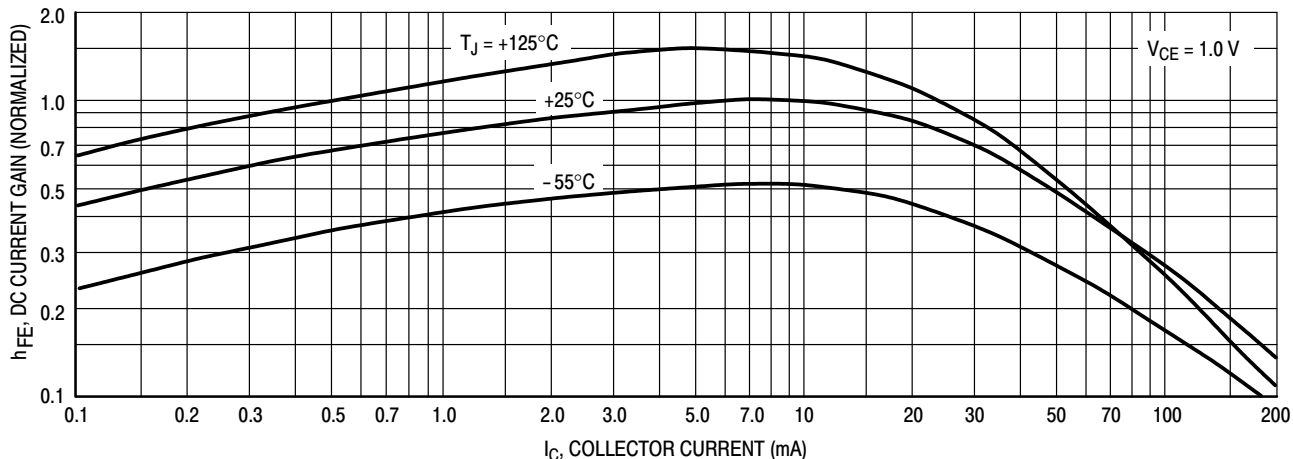

Figure 15. DC Current Gain

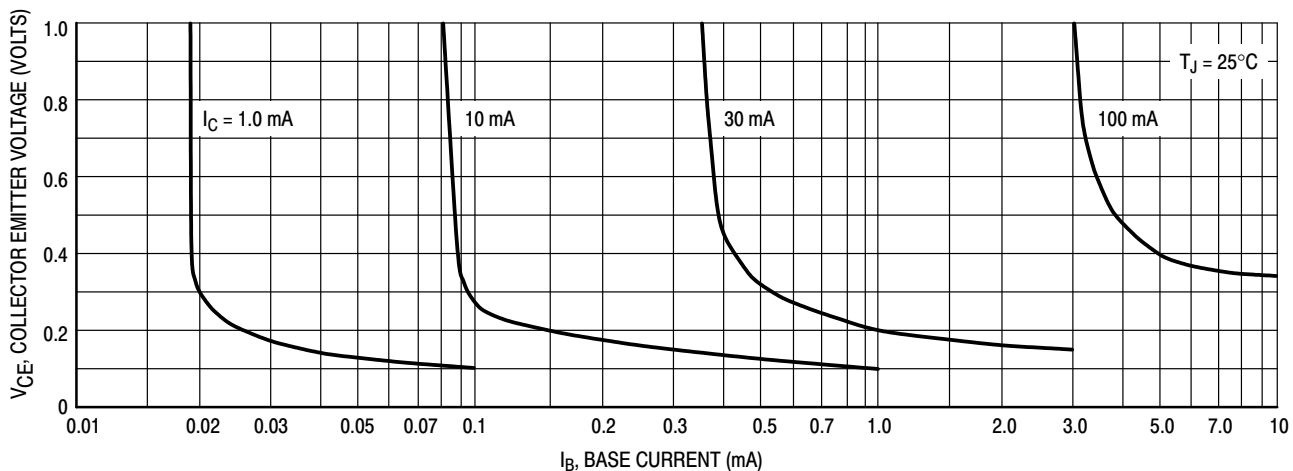

Figure 16. Collector Saturation Region

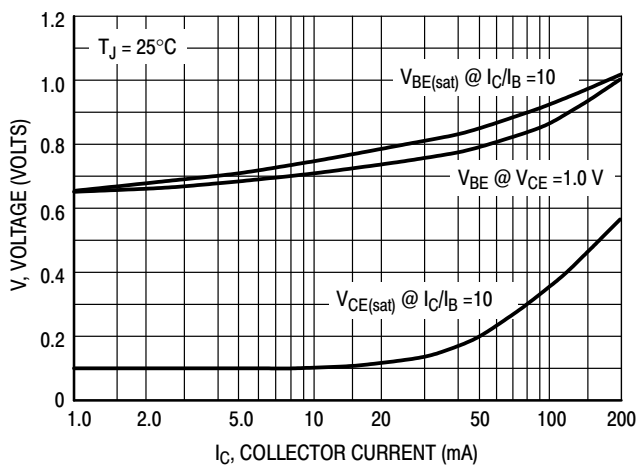

Figure 17. "ON" Voltages

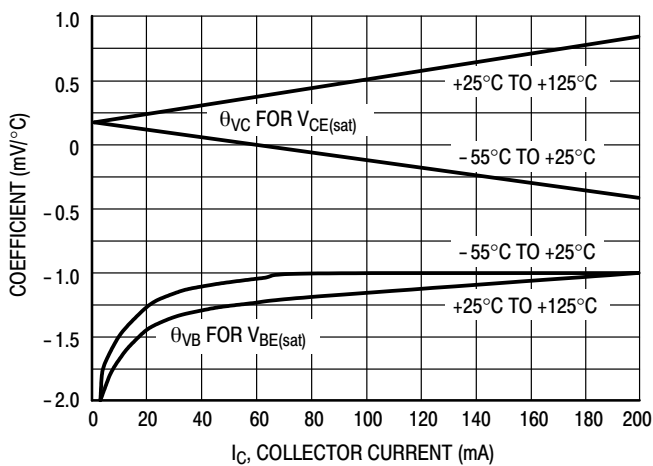

Figure 18. Temperature Coefficients

# MECHANICAL CASE OUTLINE PACKAGE DIMENSIONS

ON Semiconductor®



SCALE 1:1



TO-92 (TO-226)  
CASE 29-11  
ISSUE AM

DATE 09 MAR 2007



STRAIGHT LEAD  
BULK PACK



NOTES:

1. DIMENSIONING AND TOLERANCING PER ANSI Y14.5M, 1982.
2. CONTROLLING DIMENSION: INCH.
3. CONTOUR OF PACKAGE BEYOND DIMENSION R IS UNCONTROLLED.
4. LEAD DIMENSION IS UNCONTROLLED IN P AND BEYOND DIMENSION K MINIMUM.

DIM	INCHES		MILLIMETERS	
	MIN	MAX	MIN	MAX
A	0.175	0.205	4.45	5.20
B	0.170	0.210	4.32	5.33
C	0.125	0.165	3.18	4.19
D	0.016	0.021	0.407	0.533
G	0.045	0.055	1.15	1.39
H	0.095	0.105	2.42	2.66
J	0.015	0.020	0.39	0.50
K	0.500	---	12.70	---
L	0.250	---	6.35	---
N	0.080	0.105	2.04	2.66
P	---	0.100	---	2.54
R	0.115	---	2.93	---
V	0.135	---	3.43	---



BENT LEAD  
TAPE & REEL  
AMMO PACK



NOTES:

1. DIMENSIONING AND TOLERANCING PER ASME Y14.5M, 1994.
2. CONTROLLING DIMENSION: MILLIMETERS.
3. CONTOUR OF PACKAGE BEYOND DIMENSION R IS UNCONTROLLED.
4. LEAD DIMENSION IS UNCONTROLLED IN P AND BEYOND DIMENSION K MINIMUM.

DIM	MILLIMETERS	
	MIN	MAX
A	4.45	5.20
B	4.32	5.33
C	3.18	4.19
D	0.40	0.54
G	2.40	2.80
J	0.39	0.50
K	12.70	---
N	2.04	2.66
P	1.50	4.00
R	2.93	---
V	3.43	---

STYLES ON PAGE 2

DOCUMENT NUMBER:	98ASB42022B	Electronic versions are uncontrolled except when accessed directly from the Document Repository. Printed versions are uncontrolled except when stamped "CONTROLLED COPY" in red.
STATUS:	ON SEMICONDUCTOR STANDARD	
NEW STANDARD:		
DESCRIPTION:	TO-92 (TO-226)	PAGE 1 OF 3

**TO-92 (TO-226)**  
**CASE 29-11**  
**ISSUE AM**

DATE 09 MAR 2007

STYLE 1:  
 PIN 1. EMITTER  
 2. BASE  
 3. COLLECTOR

STYLE 2:  
 PIN 1. BASE  
 2. EMITTER  
 3. COLLECTOR

STYLE 3:  
 PIN 1. ANODE  
 2. ANODE  
 3. CATHODE

STYLE 4:  
 PIN 1. CATHODE  
 2. CATHODE  
 3. ANODE

STYLE 5:  
 PIN 1. DRAIN  
 2. SOURCE  
 3. GATE

STYLE 6:  
 PIN 1. GATE  
 2. SOURCE & SUBSTRATE  
 3. DRAIN

STYLE 7:  
 PIN 1. SOURCE  
 2. DRAIN  
 3. GATE

STYLE 8:  
 PIN 1. DRAIN  
 2. GATE  
 3. SOURCE & SUBSTRATE

STYLE 9:  
 PIN 1. BASE 1  
 2. EMITTER  
 3. BASE 2

STYLE 10:  
 PIN 1. CATHODE  
 2. GATE  
 3. ANODE

STYLE 11:  
 PIN 1. ANODE  
 2. CATHODE & ANODE  
 3. CATHODE

STYLE 12:  
 PIN 1. MAIN TERMINAL 1  
 2. GATE  
 3. MAIN TERMINAL 2

STYLE 13:  
 PIN 1. ANODE 1  
 2. GATE  
 3. CATHODE 2

STYLE 14:  
 PIN 1. EMITTER  
 2. COLLECTOR  
 3. BASE

STYLE 15:  
 PIN 1. ANODE 1  
 2. CATHODE  
 3. ANODE 2

STYLE 16:  
 PIN 1. ANODE  
 2. GATE  
 3. CATHODE

STYLE 17:  
 PIN 1. COLLECTOR  
 2. BASE  
 3. EMITTER

STYLE 18:  
 PIN 1. ANODE  
 2. CATHODE  
 3. NOT CONNECTED

STYLE 19:  
 PIN 1. GATE  
 2. ANODE  
 3. CATHODE

STYLE 20:  
 PIN 1. NOT CONNECTED  
 2. CATHODE  
 3. ANODE

STYLE 21:  
 PIN 1. COLLECTOR  
 2. EMITTER  
 3. BASE

STYLE 22:  
 PIN 1. SOURCE  
 2. GATE  
 3. DRAIN

STYLE 23:  
 PIN 1. GATE  
 2. SOURCE  
 3. DRAIN

STYLE 24:  
 PIN 1. EMITTER  
 2. COLLECTOR/ANODE  
 3. CATHODE

STYLE 25:  
 PIN 1. MT 1  
 2. GATE  
 3. MT 2

STYLE 26:  
 PIN 1. V<sub>CC</sub>  
 2. GROUND 2  
 3. OUTPUT

STYLE 27:  
 PIN 1. MT  
 2. SUBSTRATE  
 3. MT

STYLE 28:  
 PIN 1. CATHODE  
 2. ANODE  
 3. GATE

STYLE 29:  
 PIN 1. NOT CONNECTED  
 2. ANODE  
 3. CATHODE

STYLE 30:  
 PIN 1. DRAIN  
 2. GATE  
 3. SOURCE

STYLE 31:  
 PIN 1. GATE  
 2. DRAIN  
 3. SOURCE

STYLE 32:  
 PIN 1. BASE  
 2. COLLECTOR  
 3. EMITTER

STYLE 33:  
 PIN 1. RETURN  
 2. INPUT  
 3. OUTPUT

STYLE 34:  
 PIN 1. INPUT  
 2. GROUND  
 3. LOGIC

STYLE 35:  
 PIN 1. GATE  
 2. COLLECTOR  
 3. EMITTER

<b>DOCUMENT NUMBER:</b>	<b>98ASB42022B</b>	Electronic versions are uncontrolled except when accessed directly from the Document Repository. Printed versions are uncontrolled except when stamped "CONTROLLED COPY" in red.
<b>STATUS:</b>	<b>ON SEMICONDUCTOR STANDARD</b>	
<b>NEW STANDARD:</b>		
<b>DESCRIPTION:</b>	<b>TO-92 (TO-226)</b>	<b>PAGE 2 OF 3</b>





ISSUE	REVISION	DATE
AM	ADDED BENT-LEAD TAPE & REEL VERSION. REQ. BY J. SUPINA.	09 MAR 2007

ON Semiconductor and  are registered trademarks of Semiconductor Components Industries, LLC (SCILLC). SCILLC reserves the right to make changes without further notice to any products herein. SCILLC makes no warranty, representation or guarantee regarding the suitability of its products for any particular purpose, nor does SCILLC assume any liability arising out of the application or use of any product or circuit, and specifically disclaims any and all liability, including without limitation special, consequential or incidental damages. "Typical" parameters which may be provided in SCILLC data sheets and/or specifications can and do vary in different applications and actual performance may vary over time. All operating parameters, including "Typicals" must be validated for each customer application by customer's technical experts. SCILLC does not convey any license under its patent rights nor the rights of others. SCILLC products are not designed, intended, or authorized for use as components in systems intended for surgical implant into the body, or other applications intended to support or sustain life, or for any other application in which the failure of the SCILLC product could create a situation where personal injury or death may occur. Should Buyer purchase or use SCILLC products for any such unintended or unauthorized application, Buyer shall indemnify and hold SCILLC and its officers, employees, subsidiaries, affiliates, and distributors harmless against all claims, costs, damages, and expenses, and reasonable attorney fees arising out of, directly or indirectly, any claim of personal injury or death associated with such unintended or unauthorized use, even if such claim alleges that SCILLC was negligent regarding the design or manufacture of the part. SCILLC is an Equal Opportunity/Affirmative Action Employer. This literature is subject to all applicable copyright laws and is not for resale in any manner.

**onsemi**, **Onsemi**, and other names, marks, and brands are registered and/or common law trademarks of Semiconductor Components Industries, LLC dba "**onsemi**" or its affiliates and/or subsidiaries in the United States and/or other countries. **onsemi** owns the rights to a number of patents, trademarks, copyrights, trade secrets, and other intellectual property. A listing of **onsemi**'s product/patent coverage may be accessed at [www.onsemi.com/site/pdf/Patent-Marking.pdf](http://www.onsemi.com/site/pdf/Patent-Marking.pdf). **onsemi** reserves the right to make changes at any time to any products or information herein, without notice. The information herein is provided "as-is" and **onsemi** makes no warranty, representation or guarantee regarding the accuracy of the information, product features, availability, functionality, or suitability of its products for any particular purpose, nor does **onsemi** assume any liability arising out of the application or use of any product or circuit, and specifically disclaims any and all liability, including without limitation special, consequential or incidental damages. Buyer is responsible for its products and applications using **onsemi** products, including compliance with all laws, regulations and safety requirements or standards, regardless of any support or applications information provided by **onsemi**. "Typical" parameters which may be provided in **onsemi** data sheets and/or specifications can and do vary in different applications and actual performance may vary over time. All operating parameters, including "Typicals" must be validated for each customer application by customer's technical experts. **onsemi** does not convey any license under any of its intellectual property rights nor the rights of others. **onsemi** products are not designed, intended, or authorized for use as a critical component in life support systems or any FDA Class 3 medical devices or medical devices with a same or similar classification in a foreign jurisdiction or any devices intended for implantation in the human body. Should Buyer purchase or use **onsemi** products for any such unintended or unauthorized application, Buyer shall indemnify and hold **onsemi** and its officers, employees, subsidiaries, affiliates, and distributors harmless against all claims, costs, damages, and expenses, and reasonable attorney fees arising out of, directly or indirectly, any claim of personal injury or death associated with such unintended or unauthorized use, even if such claim alleges that **onsemi** was negligent regarding the design or manufacture of the part. **onsemi** is an Equal Opportunity/Affirmative Action Employer. This literature is subject to all applicable copyright laws and is not for resale in any manner.

## PUBLICATION ORDERING INFORMATION

### LITERATURE FULFILLMENT:

Email Requests to: [orderlit@onsemi.com](mailto:orderlit@onsemi.com)

**onsemi Website:** [www.onsemi.com](http://www.onsemi.com)

### TECHNICAL SUPPORT

**North American Technical Support:**

Voice Mail: 1 800-282-9855 Toll Free USA/Canada

Phone: 011 421 33 790 2910

**Europe, Middle East and Africa Technical Support:**

Phone: 00421 33 790 2910

For additional information, please contact your local Sales Representative